

LCD50W FED100W Series

DC/DC Converters



Industrial



Reliable and High-performance DC/DC Converters Can Fulfill The Needs of Diverse Industries.

High-Efficiency Compact DC/DC Converters: LCD50W and FED100W Series

P-DUKE proudly presents the new DC/DC converter series, LCD50W, and FED100W, featuring compact 1"x1" and 2"x1" designs. These converters cater to the rigorous demands of modern technology and electronic systems, offering exceptional power density, efficiency, and reliability.

The LCD50W series delivers up to 50W of output power within its compact 1"x1" industrial standard package. It supports input voltage ranges of 9 to 36 Vdc and 18 to 75 Vdc, providing single and dual outputs of 5, 12, 15, 24, ±12, ±15, and ±24 Vdc.

The FED100W series offers up to 100W of output power in a compact 2"x1" package. It accommodates input voltage ranges from 9 to 36 Vdc and 18 to 75 Vdc, with single outputs of 5, 12, 15, 24, 28, 48, and 54 Vdc.

Both series boast high power densities of up to 238W/in³, making them an ideal space-saving solution for system integration. With a remarkable 94% conversion efficiency, they minimize power loss and heat generation, extending operating temperatures to ease thermal management challenges. Certified to IEC/EN/UL 62368-1 standard and compliant with MIL-STD-810F for shock and vibration, these converters operate at altitudes up to 5000 meters and within ambient temperatures ranging from -40°C to +110°C. Their 4:1 input voltage range makes them perfect for rugged, high-reliability applications such as servo systems, automation control, measurement instruments, and automated inspection equipment.

Features

- LCD50W: 50W Output Power
FED100W: 100W Output Power
- 4:1 Wide Input Range From 9 to 36 and 18 to 75V
- Output Voltage:
LCD50W: 5, 12, 15, 24, ±12, ±15, and ±24 Vdc
FED100W: 5, 12, 15, 24, 28, 48, and 54 Vdc
- 5000m Operating Altitude
- IEC/UL/EN 62368-1 Safety Approval *pending
- 3 Years Product Warranty

Applications

- Servo systems
- Automation control
- Measurement instrument
- Automated inspection equipment

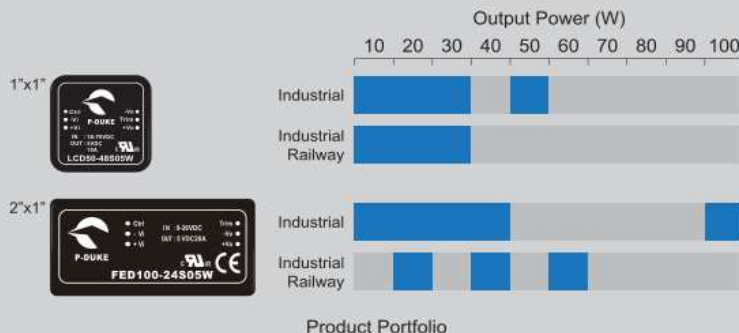

P-DUKE Technology Co., Ltd.

Tel: +886-4-2359-0668 | E-mail: sales@pduke.com | Web: www.pduke.com

www.pduke.com is the only official website of P-DUKE Technology. Please pay attention to unauthorized phishing websites and support the crackdown on counterfeit products. If you have any questions about whether the product is sold by a legitimate authorized dealer, please contact us to inquire about the authenticity of the product or authorization.

【お問い合わせ先】

JEMCO 株式会社ジェムコ
 大阪本社 TEL : 06-6338-8566
 東京 TEL : 080-6449-9194
 名古屋 TEL : 0587-96-1970
 URL : <http://www.jemc.co.jp/>
 E-Mail : inf@jemc.co.jp



P-DUKE POWER

LCD50W Series

DC-DC Converter
Up to 50 Watts

3
YEARS
WARRANTY

ROHS
COMPLIANT

REACH
COMPLIANT

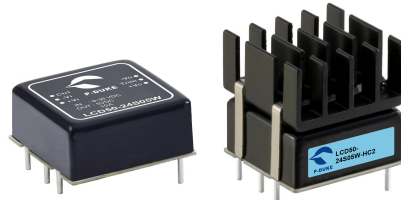

Automation



Datacom



IPC



Industry



Measurement



Telecom



Automobile



Boat



Charger



Medical



PV



Railway



2250
VDC
Isolation
Voltage

4 : 1
Wide
Input
Range

6
sided
Shielding

LOW
Standby
Power

NO
Min. Load
Required

Operating
Altitude
5000
meter

REMOTE
ON
OFF

OCP

OTP

OVP

SCP

UVP

PART NUMBER STRUCTURE

LCD50	-	48	S	05	W	-	A	HC1
Series Name		Input Voltage (VDC)	Output Quantity	Output Voltage (VDC)	Input Range		Remote On/Off Options	Assembly Options
		24:9~36 48:18~75	S:Single D: Dual	05:5 12:12 15:15 24:24 12:±12 15:±15 24:±24	4:1		□: Negative logic A: Positive logic	□: None HC1: 7GA0117P01-F; H=0.3" HC2: 7GA0118P01-F; H=0.5" HC3: 7GA0119P01-F; H=0.8"

TECHNICAL SPECIFICATION All specifications are typical at nominal input, full load and 25°C unless otherwise noted

Model Number	Input Range	Output Voltage	Output Current @Full Load	Input Current @No Load	Efficiency	Maximum Capacitor Load
	VDC	VDC	A	mA	%	µF
LCD50-24S05W	9 ~ 36	5	10	15	90	14400
LCD50-24S12W	9 ~ 36	12	4.2	15	92	2520
LCD50-24S15W	9 ~ 36	15	3.33	15	92	1630
LCD50-24S24W	9 ~ 36	24	2.1	15	90	630
LCD50-24D12W	9 ~ 36	±12	±2.1	15	90	±1260
LCD50-24D15W	9 ~ 36	±15	±1.7	15	90	±816
LCD50-24D24W	9 ~ 36	±24	±1.1	15	91	±330
LCD50-48S05W	18 ~ 75	5	10	10	90	14400
LCD50-48S12W	18 ~ 75	12	4.2	10	92	2520
LCD50-48S15W	18 ~ 75	15	3.33	10	93	1630
LCD50-48S24W	18 ~ 75	24	2.1	10	91	630
LCD50-48D12W	18 ~ 75	±12	±2.1	15	91	±1260
LCD50-48D15W	18 ~ 75	±15	±1.7	15	91	±816
LCD50-48D24W	18 ~ 75	±24	±1.1	15	91	±330

INPUT SPECIFICATIONS						
Parameter	Conditions		Min.	Typ.	Max.	Unit
Operating input voltage range	24Vin(nom)		9	24	36	VDC
	48Vin(nom)		18	48	75	
Start up voltage	24Vin(nom)					VDC
	48Vin(nom)		9			
Shutdown voltage	24Vin(nom)		7.5	8	8.8	VDC
	48Vin(nom)		15.5	16	17.5	
Start up time	Constant resistive load	Power up	30		60	ms
		Remote ON/OFF	30		60	
Input surge voltage	1 second, max.	24Vin(nom)				VDC
		48Vin(nom)	50			
Input filter			Pi type			
Remote ON/OFF	Referred to -Vin pin	Negative logic	DC-DC ON		Short or 0 ~ 1.2VDC	
		(Standard)	DC-DC OFF		Open or 3 ~ 15VDC	
		Positive logic	DC-DC ON		Open or 3 ~ 15VDC	
		(Option)	DC-DC OFF		Short or 0 ~ 1.2VDC	
		Input current of Ctrl pin	-0.5			mA
		Remote off input current	3			mA

OUTPUT SPECIFICATIONS						
Parameter	Conditions		Min.	Typ.	Max.	Unit
Voltage accuracy			-1.0		+1.0	%
Line regulation	Low Line to High Line at Full Load	Single Dual	-0.2 -0.5		+0.2 +0.5	%
Load regulation	No Load to Full Load	Single Dual	-0.2 -1.0		+0.2 +1.0	%
	10% Load to 90% Load	Single Dual	-0.1 -0.8		+0.1 +0.8	%
Cross regulation	Asymmetrical load 25%/100% FL	Dual	-5.0		+5.0	%
Voltage adjustability	Single output	15Vout, 24Vout Others	-10 -10		+20 +10	%
Ripple and noise	Measured by 20MHz bandwidth					
		Single				
	With a 22 μ F/25V X7R MLCC	5Vout		75		
	With a 22 μ F/25V X7R MLCC	12Vout, 15Vout		100		
	With a 4.7 μ F/50V X7R MLCC	24Vout		150		mVp-p
		Dual				
	With a 10 μ F/25V X7R MLCC for each output	12Vout, 15Vout		100		
	With a 4.7 μ F/50V X7R MLCC for each output	24Vout		150		
Temperature coefficient			-0.02		+0.02	%/°C
Transient response recovery time	25% load step change			250		μ s
Over voltage protection				6.5		
	5Vout			15		
	12Vout			20		VDC
	15Vout			30		
	24Vout					
Over load protection	% of Iout rated			150		%
Short circuit protection			Continuous, automatic recovery			

GENERAL SPECIFICATIONS						
Parameter	Conditions		Min.	Typ.	Max.	Unit
Isolation voltage	1 minute	Input to Output Input (Output) to Case	2250 1600			VDC
Isolation resistance	500VDC		1			G Ω
Isolation capacitance					2000	pF
Switching frequency	Dual	24Vout	270	300	330	kHz
		Others	235	270	300	
Safety approvals (Pending)			IEC/ EN/ UL62368-1			
Case material			Copper			
Base material			FR4 PCB			
Potting material			Silicone (UL94 V-0)			
Weight			22g (0.8oz)			
MTBF	MIL-HDBK-217F, Full load		7.909 x 10 ⁵ hrs			

ENVIRONMENTAL SPECIFICATIONS						
Parameter	Conditions		Min.	Typ.	Max.	Unit
Operating ambient temperature	Standard type	With derating	-40		+105	°C
Maximum case temperature					105	°C
Over temperature protection				115		°C
Storage temperature range			-55		+125	°C
Operating altitude					5000	m
Thermal impedance	Natural convection	With 3"x3" evaluation board		9.8		°C/W
Thermal shock						MIL-STD-810F
Shock						MIL-STD-810F
Vibration						MIL-STD-810F
Relative humidity						5% to 95% RH

EMC SPECIFICATIONS			
Parameter	Conditions		Level
EMI	EN55032	With external components.	Class A, Class B
EMS	EN55035		
ESD	EN61000-4-2	Air ± 8kV and Contact ± 6kV	Perf. Criteria A
Radiated immunity	EN61000-4-3	20 V/m	Perf. Criteria A
Fast transient	EN61000-4-4	±2kV	Perf. Criteria A
	LCD50-24□□□W	With 2 pcs of aluminum electrolytic capacitor (Nippon chemi-con KY series, 220µF/100V) and a TVS (SMDJ58A, 58V, 3000 Watt peak pulse power) in parallel.	
	LCD50-48□□□W	With 2 pcs of aluminum electrolytic capacitor (Nippon chemi-con KY series, 220µF/100V) and a TVS (SMDJ120A, 120V, 3000 Watt peak pulse power) in parallel.	
Surge	EN61000-4-5	±2kV	Perf. Criteria A
	LCD50-24□□□W	With 2 pcs of aluminum electrolytic capacitor (Nippon chemi-con KY series, 220µF/100V) and a TVS (SMDJ58A, 58V, 3000 Watt peak pulse power) in parallel.	
	LCD50-48□□□W	With 2 pcs of aluminum electrolytic capacitor (Nippon chemi-con KY series, 220µF/100V) and a TVS (SMDJ120A, 120V, 3000 Watt peak pulse power) in parallel.	
Conducted immunity	EN61000-4-6	10 Vr.m.s	Perf. Criteria A
Power frequency magnetic field	EN61000-4-8	100A/m continuous; 1000A/m 1 second	Perf. Criteria A

CAUTION: This power module is not internally fused. An input line fuse must always be used.

CHARACTERISTIC CURVE

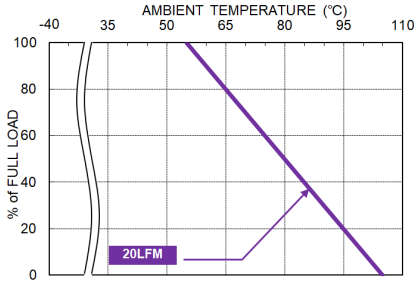

LCD50-48D24W Derating Curve
(Mount on 3"x3" Evaluation board)

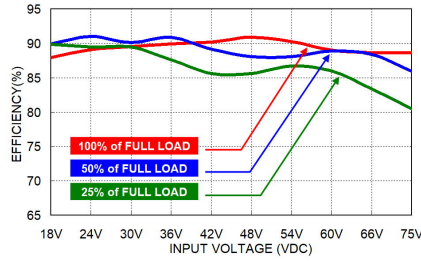

LCD50-48D24W Efficiency vs. Input Voltage

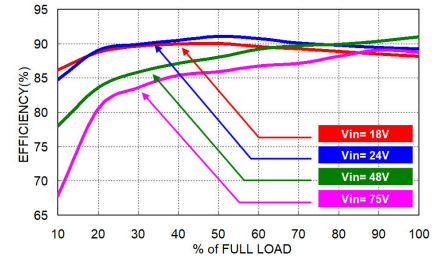

LCD50-48D24W Efficiency vs. Output Load

FUSE CONSIDERATION

This power module is not internally fused. An input line fuse must always be used.

This encapsulated power module can be used in a wide variety of applications, ranging from simple stand-alone operation to an integrated part of sophisticated power architecture.

To maximum flexibility, internal fusing is not included; however, to achieve maximum safety and system protection, always use an input line fuse.

The input line fuse suggest as below :

Modules	Fuse Rating (A)	Fuse Type
LCD50-24□□□W	10	Fast-Acting
LCD50-48□□□W	5	Slow-Blow

The table based on the information provided in this data sheet on inrush energy and maximum DC input current at low Vin.

MECHANICAL DRAWING

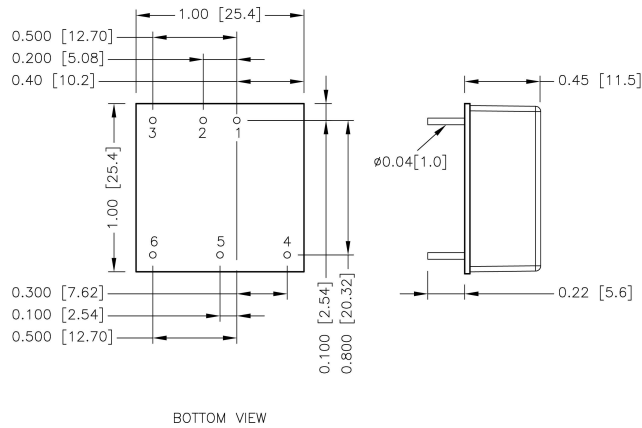

PIN CONNECTION

PIN	SINGLE	DUAL
1	+Vin	+Vin
2	-Vin	-Vin
3	Ctrl	Ctrl
4	+Vout	+Vout
5	Trim	Common
6	-Vout	-Vout

1. All dimensions in inch [mm]
2. Tolerance :x.xx±0.02 [x.x±0.5]
x.xxx±0.01 [x.xx±0.25]
3. Pin dimension tolerance ±0.004[0.10]

RECOMMENDED PAD LAYOUT

Standard

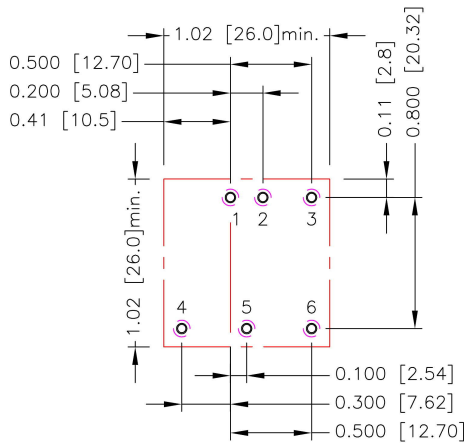

-HC1、-HC2、-HC3

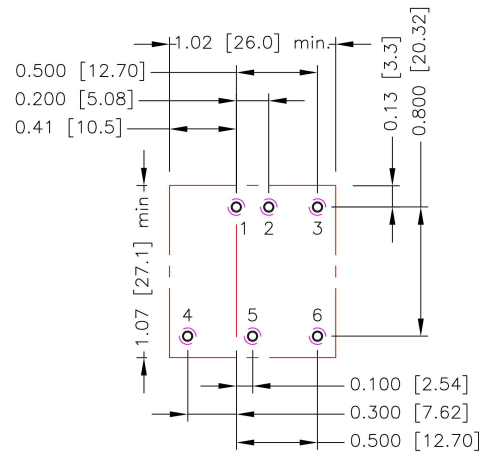

All dimensions in inch[mm]
 Pad size(lead free recommended)
 Through hole 1.2.3.4.5.6: $\Phi 0.051 [1.30]$
 Top view pad 1.2.3.4.5.6: $\Phi 0.064 [1.63]$
 Bottom view pad 1.2.3.4.5.6: $\Phi 0.102 [2.60]$

All dimensions in inch[mm]
 Pad size(lead free recommended)
 Through hole 1.2.3.4.5.6: $\Phi 0.051 [1.30]$
 Top view pad 1.2.3.4.5.6: $\Phi 0.064 [1.63]$
 Bottom view pad 1.2.3.4.5.6: $\Phi 0.102 [2.60]$

THERMAL CONSIDERATIONS

The power module operates in a variety of thermal environments.

However, sufficient cooling should be provided to help ensure reliable operation of the unit.

Heat is removed by conduction, convection, and radiation to the surrounding environment.

Proper cooling can be verified by measuring the point as the figure below.

The temperature at this location should not exceed “Maximum case temperature”.

When operating, adequate cooling must be provided to maintain the test point temperature at or below “Maximum case temperature”.

You can limit this temperature to a lower value for extremely high reliability.

- Thermal test condition with vertical direction by natural convection (20LFM).

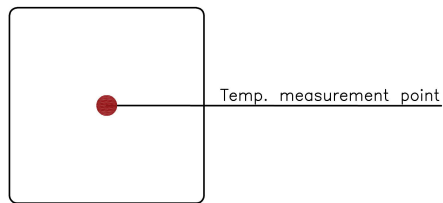

TOP VIEW

HEAT-SINK TYPE OPTIONS

LCD50-□□□□□W-**HC1**
7GA0117P01-F

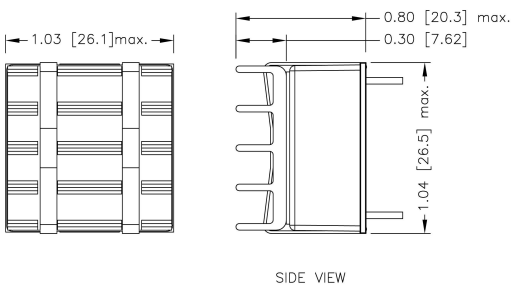

SIDE VIEW

LCD50-□□□□□W-**HC2**
7GA0118P01-F

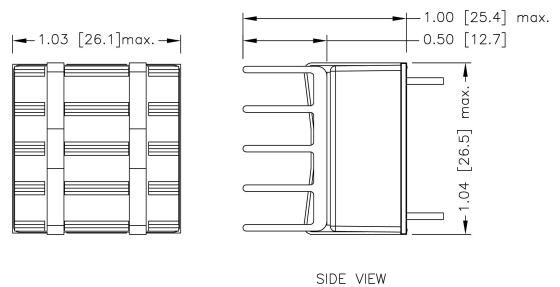

SIDE VIEW

LCD50-□□□□□W-**HC3**
7GA0119P01-F

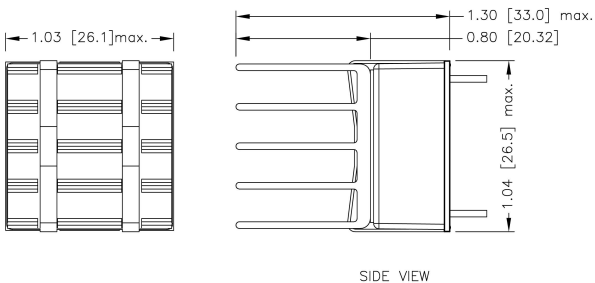

SIDE VIEW

- All dimensions in inch [mm]
- Tolerance :x.xx±0.02 [x.x±0.5]
x.xxx±0.010 [x.xx±0.25]

OUTPUT VOLTAGE ADJUSTMENT

Output voltage set point adjustment allows the user to increase or decrease the output voltage set point of the module. This is accomplished by connecting an external resistor between the Trim pin and either the +Output or -Output pins. With an external resistor between the Trim and -Output pin, the output voltage set point increases. With an external resistor between the Trim and +Output pin, the output voltage set point decreases. The external Trim resistor needs to be at least 1/16W of rated power.

■ Trim Up Equation

$$R_U = \left[\frac{G \times L}{(V_{o,up} - L - K)} - H \right] \Omega$$

■ Trim Down Equation

$$R_D = \left[\frac{(V_{o,down} - L) \times G}{(V_o - V_{o,down})} - H \right] \Omega$$

■ Trim Constants

Module	G	H	K	L
LCD50-□□S05W	5110	2050	2.5	2.5
LCD50-□□S12W	10000	5110	9.5	2.5
LCD50-□□S15W	10000	5110	12.5	2.5
LCD50-□□S24W	56000	13000	21.5	2.5

EXTERNAL OUTPUT TRIMMING

Output can be externally trimmed by using the method shown below.

Trim-up

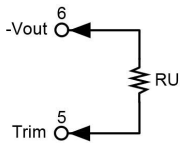

□□S05W

ΔV (%)	1	2	3	4	5	6	7	8	9	10
Vout (V)	5.050	5.100	5.150	5.200	5.250	5.300	5.350	5.400	5.450	5.500
R _U (kΩ)	253.450	125.700	83.117	61.825	49.050	40.533	34.450	29.888	26.339	23.500

□□S12W

ΔV (%)	1	2	3	4	5	6	7	8	9	10
Vout (V)	12.120	12.240	12.360	12.480	12.600	12.720	12.840	12.960	13.080	13.200
R _U (kΩ)	203.223	99.057	64.334	46.973	36.557	29.612	24.652	20.932	18.038	15.723

□□S15W

ΔV (%)	1	2	3	4	5	6	7	8	9	10
Vout (V)	15.150	15.300	15.450	15.600	15.750	15.900	16.050	16.200	16.350	16.500
R _U (kΩ)	161.557	78.223	50.446	36.557	28.223	22.668	18.700	15.723	13.409	11.557

ΔV (%)	11	12	13	14	15	16	17	18	19	20
Vout (V)	16.650	16.800	16.950	17.100	17.250	17.400	17.550	17.700	17.850	18.000
R _U (kΩ)	10.042	8.779	7.711	6.795	6.001	5.307	4.694	4.149	3.662	3.223

□□S24W

ΔV (%)	1	2	3	4	5	6	7	8	9	10
Vout (V)	24.240	24.480	24.720	24.960	25.200	25.440	25.680	25.920	26.160	26.400
R _U (kΩ)	570.333	278.667	181.444	132.833	103.667	84.222	70.333	59.917	51.815	45.333

ΔV (%)	11	12	13	14	15	16	17	18	19	20
Vout (V)	26.640	26.880	27.120	27.360	27.600	27.840	28.080	28.320	28.560	28.800
R _U (kΩ)	40.030	35.611	31.872	28.667	25.889	23.458	21.314	19.407	17.702	16.167

OUTPUT VOLTAGE ADJUSTMENT(CONTINUED)

Trim-down

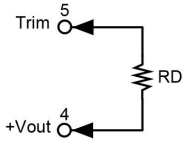

□□S05W

ΔV (%)	1	2	3	4	5	6	7	8	9	10
Vout (V)	4.950	4.900	4.850	4.800	4.750	4.700	4.650	4.600	4.550	4.500
RD (k Ω)	248.340	120.590	78.007	56.715	43.940	35.423	29.340	24.778	21.229	18.390

□□S12W

ΔV (%)	1	2	3	4	5	6	7	8	9	10
Vout (V)	11.880	11.760	11.640	11.520	11.400	11.280	11.160	11.040	10.920	10.800
RD (k Ω)	776.557	380.723	248.779	182.807	143.223	116.834	97.985	83.848	72.853	64.057

□□S15W

ΔV (%)	1	2	3	4	5	6	7	8	9	10
Vout (V)	14.850	14.700	14.550	14.400	14.250	14.100	13.950	13.800	13.650	13.500
RD (k Ω)	818.223	401.557	262.668	193.223	151.557	123.779	103.938	89.057	77.483	68.223

□□S24W

ΔV (%)	1	2	3	4	5	6	7	8	9	10
Vout (V)	23.760	23.520	23.280	23.040	22.800	22.560	22.320	22.080	21.840	21.600
RD (k Ω)	4947.667	2439.333	1603.222	1185.167	934.333	767.111	647.667	558.083	488.407	432.667